

PODS30C micro-Guidance Pod

Model: PODS30C

PRODUCT DESCRIPTION

The PODS30C micro-pod features an extremely compact structure, weighing less than 90g. It is resistant to launch impacts and compatible with catapult - launched drones. Equipped with servo image stabilization, built - in tracking and AI recognition technologies, it can achieve stable observation and intelligent target processing in a compact fuselage, providing lightweight and high - performance payload support for drone missions.



TECHNICAL PARAMETER

System specification	
System type	Gyro stability
Weight	≤90g
System characteristics	
Platform type	Single-axis
Pitch	-90°~+90°
Max angular velocity	≥60°/s
Vibration angle	0.1mrad(1°/2HZ)(1σ)
Encoder accuracy	≤0.3°
Visible Light Imaging (Large Field of View)	
Resolution and frame rate	1920×1080@60fps
FOV	82.0°×52.2°(3.2mm)
Visible Light Imaging (Narrow Field of View)	
Resolution and frame rate	1920×1080@60fps
FOV	30.0°×17.2° (10.36mm)
Tracking module	
Tracking speed	≥40°/s
AI recognition	
Target type	Human & Vehicle
System external interface	

Control interface	TTL
Video output	Network/AV
Power supply	
Supply voltage	12V & 5V
Power consumption	Av.≤10W Max.≤20W
Environmental condition	
Working temp	-40°C~+60°C
Storage temp	-40°C~+60°C
High-G shock resistance	≥400g

MECHANICAL STRUCTURE

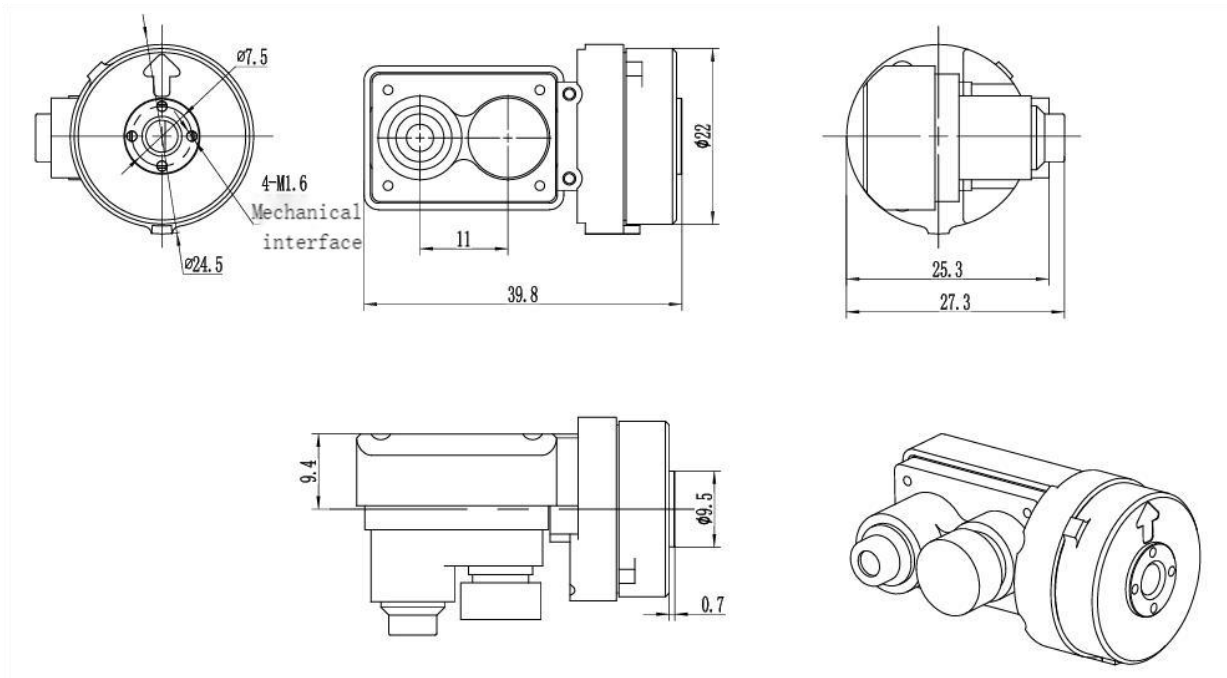

CONTROL PROTOCOL

1 Scope

This agreement specifies the data communication process and control protocol between DYT and controllers (such as flight control and pod controllers).

2 Communication between DYT and Controllers

2.1 Data Communication Process

- The controller sends instructions to DYT. The instruction content is shown in Table 1. All instructions are trigger-type and only need to be sent once.
- After DYT powers on and completes self-check, it sends information to the controller at a cycle of 16.7 ms. The information content is shown in Table 2.
- For multi-byte variables, the low byte comes first, followed by the high byte.

- d) The default baud rate of the serial port is 115200, and the parity check mode is no parity.
- e) When target position calculation and data guidance functions are required, the attitude angles and latitude-longitude information of the carrier aircraft need to be sent to DYT at a frequency of 1–60 Hz.
- f) SEI information is data superimposed in the H.264 video stream and is disabled by default.

2.2 Communication Protocol

Table 1 Control Instruction Data

Data source		Controller		
Destination		DYT		
Transmission Frequency		Trigger to Send		
Byte Sequence Number	Parameter Name	Data Type	Explanation	Bytes Occupied
0	Synchronous code 1	U8	0xEB	1
1	Synchronous code 2	U8	0x90	1
2	Control Information	U8	0x00: Null Command 0x01: Visible Light 1 0x02: Visible Light 2 0x03: Infrared 1 0x04: Infrared 2 0x05: Image Enhancement On 0x06: Image Enhancement Off (Default) 0x07: Target Recognition On 0x08: Target Recognition Off (Default) 0x09: Storage On 0x0A: Storage Off (Default) 0x0D: Point Tracking (X, Y Coordinates) 0x0E: Stop Tracking 0x0F: Automatic Target Locking 0x10: Semi-Automatic Target Locking 0x11: Infrared White Hot 0x12: Infrared Black Hot 0x13: Tracking Algorithm - Adaptive 0x14: Tracking Algorithm - Personnel 0x15: Tracking Algorithm - Vehicle 0x16: Tracking Algorithm - Building 0x24: Pan/Tilt Search 0x25: Zoom Command 0x26: Specify Frame Angle 0x27: Motor On 0x28: Motor Off 0x29: Follow Mode Off	1

			<p>0x2A: Azimuth Follow</p> <p>0x2B: Center Position</p> <p>0x2C: Suppress Gyro Drift</p> <p>0x2D: Laser Ranging On</p> <p>0x2E: Laser Ranging Off</p> <p>0x30: Electric Lock Mode</p> <p>0x31: Release Electric Lock</p> <p>0x32: Azimuth Scanning</p> <p>0x33: Stop Scanning</p> <p>0x39: Calibrate Gyroscope (Parameter 3 is zero. Turn off the motor first, keep stationary for 10s after sending the command, then turn on the motor.)</p> <p>0x3A: Data Guidance</p> <p>0x3B: Specify Attitude Angle</p> <p>0x3C: Calibrate Zero Position of Flight Control and Pod Attitude Angles</p> <p>0x4A: Image Board Power Control</p> <p>0x50: Pseudo Color</p> <p>0x51: OSD Display On</p> <p>0x52: OSD Display Off</p> <p>0x55: Low Light Mode Off</p> <p>0x56: Low Light Mode On</p> <p>0x58: Digital Zoom On</p> <p>0x59: Digital Zoom Off</p> <p>0x5A: Specify Zoom Factor</p> <p>0x5B: Take Photo</p> <p>0x5C: Focus Mode</p> <p>0x5D: Focus Position</p> <p>0xA0: Save FLASH Parameters</p> <p>0xB0: Lifting Mechanism Control</p> <p>0xB1: Set Current Angle as Zero Position</p>	
3、4	Parameter X	S16	<p>Default value is 0.</p> <p>When Control Information = 0x0D (Point Tracking): Represents the horizontal pixel coordinate of the locking point. The image center is 0.</p> <p>When Control Information = 0x24 (Pan/Tilt Search): Represents the azimuth rotation speed in units of 0.1°/s.</p> <p>When Control Information = 0x26 (Specify Frame Angle), 0x32 (Azimuth Scanning), or 0x3B (Specify Spatial Angle): Represents the azimuth angle in units of 0.01°.</p> <p>When Control Information = 0x2C (Suppress Gyro Drift): Data type is int16 with a range of -2000 to 2000.</p> <p>When Control Information = 0x5A (Specify Zoom Factor): Represents the zoom factor in units of 0.1x.</p> <p>When Control Information = 0xB0 (Lifting Control):</p>	2

			0 = Stop, 1 = Ascend, 2 = Descend. When Control Information = 0x4A (Image Board Power Control): 0 = Restart, 1 = Power On, 2 = Power Off.	
5、 6	Parameter Y	S16	Default value is 0. When Control Information = 0x0D (Point Tracking): Represents the vertical pixel coordinate of the locking point. The image center is 0. When Control Information = 0x24 (Pan/Tilt Search): Represents the pitch rotation speed in units of 0.1°/s. When Control Information = 0x26 (Specify Frame Angle), 0x32 (Azimuth Scanning), or 0x3B (Specify Spatial Angle): Represents the pitch angle in units of 0.01°.	2
7	Parameter 3	U8	When the control information is 0x01 to 0x04: It represents the small picture in picture-in-picture. 0 = Cancel multi-screen; 1 = Visible 1; 2 = Visible 2; 3 = Infrared 1; 4 = Infrared 2; When the small picture is the same as the large picture, the multi-screen is canceled. When the control information is 0x32 "Azimuth Scanning", it represents the scanning speed, where 1 bit = 0.2°/s.	1
8	Zoom Rate	S8	When the control information is "Zoom Command", 0 to +100 represents the zoom-in rate, and 0 to -100 represents the zoom-out rate.	1
9~14	Keep			6
15	Checksum	U8	Start adding from the 0th byte, and take the lower 8 bits.	1
	Total			16

When the control information is 0x3a "Data Guidance", bytes 3 to 14 are as shown in the following table.

Byte Sequence Number	Parameter Name	Data Type	Unit	Explanation	Bytes Occupied
3	Data Guidance Status	U8		0x00: Exit Geographic Tracking 0x01: Geographic Tracking of Current Field of View Center Position 0x02: Geographic Tracking of Specified Position 0x0A: Calibration Based on Known Target	1
4~7	Target Latitude	Int32	10 ⁻⁷ °		4
8~11	Target Longitude	Int32	10 ⁻⁷ °		4
12、 13	Target Altitude	S16	0.2m		2
14	Reserved	U8			1

Command Examples:

Rotate right at 10°/s: EB 90 24 64 00 00 00 00 00 00 00 00 00 00 03

Rotate down at 10°/s: EB 90 24 00 00 9C FF 00 00 00 00 00 00 00 3A
 Stop rotation: EB 90 24 00 00 00 00 00 00 00 00 00 00 00 9F
 Go to azimuth 10°, pitch -10°: EB 90 26 E8 03 18 FC 00 00 00 00 00 00 00 A0
 Zoom in: EB 90 25 00 00 00 00 32 00 00 00 00 00 00 D2
 Zoom out: EB 90 25 00 00 00 00 CE 00 00 00 00 00 00 6E
 Stop zooming: EB 90 25 00 00 00 00 00 00 00 00 00 00 00 A0
 Zoom to 5x: EB 90 5A 32 00 00 00 32 00 00 00 00 00 00 39
 Point tracking at coordinates (100, -200): EB 90 0D 64 00 37 FF 01 32 00 00 00 00 00 55
 Stop tracking: EB 90 0E 00 00 00 00 00 00 00 00 00 00 00 89

Table 2 Periodic Telemetry Information

Data source		Controller			
Destination		DYT			
Transmission Frequency		60Hz			
Byte Sequence Number	Parameter Name	Data Type	Unit	Explanation	Bytes Occupied
0	Sync Word 1	U8		0xEE	
1	Sync Word 2	U8		0x16	
2	Status Information Feedback 1	U8		Bits 7-6: Tracking video source 00: Visible light 1 01: Visible light 2 10: Infrared 1 11: Infrared 2 Bits 5-4: Tracking algorithm type 00: Adaptive 01: Personnel 10: Vehicle 11: Building Bit 3: Target automatic prompt 1: On 0: Off Bit 2: Target tracking status 1: Locked 0: Searching Bits 1-0: Reserved	1
3				Bits 7: Image Enhancement 1: On 0: Off Bit 6: Reserved Bit 5: Storage 1: On 0: Off Bit 4: Roll Axis Mode	1

	Status Information Feedback 2	U8		0: Reset 1: Control Bit 3: Motor Status 1: On 0: Off Bit 2: Follow Mode 1: On 0: Off Bit 1: Electric Lock Mode 1: On 0: Off Bit 0: Laser Status 1: On 0: Off	
4	Least Significant 8 Bits of Zoom Factor	U8	0.1x	Combined with bits 0-3 of byte 5 to form a u16.	1
5	Status Feedback Information 3	U8		Bits 7-6: Displayed large picture Bits 5-4: Displayed small picture 00: Visible 1 (Zoom/Forward View) 01: Visible 2 (Wide Angle/Side View) 10: Infrared 1 11: Infrared 2 Bits 0-3: The upper 4 bits of the zoom magnification.	1
6、7	Target miss amount X-axis offset angle	S16	0.05°	Represents the horizontal and vertical deviations of the locking point, with the image center as 0.	2
8、9	Target miss amount Y-axis offset angle	S16	0.05°	The numerical values correspond to direct physical quantities, and the different field angles of visible light and infrared lenses are uniformly calculated internally by DYT.	2
10、11	Roll frame angle	S16	0.01°	Left is negative, right is positive. Up is positive, down is negative.	2
12、13	Pitch frame angle	S16	0.01°		2
14、15	Azimuth frame angle	S16	0.01°		2
16	Gate horizontal pixels	U8	4 pixels	1bit=4 pixels	1
17	Gate vertical pixels	U8	4 pixels	1bit=4 pixels	1
18、19	Reserved				2
20、21	Roll angular velocity	S16	0.01°/s	Left is negative and right is positive.	2
22、23	Pitch angular velocity	S16	0.01°/s	Up is positive and down is negative.	2

24、25	Azimuth angular velocity	S16	0.01°/s		2
26、27	Laser ranging	U16	0.1m	0 indicates invalid.	2
28	Self-check Result	U8		Bit7: Self-check completion 1: Self-check completed 0: Self-check in progress Bits3~Bit6: Reserved Bit2: Gyroscope calibration 1: Calibration failed 0: Calibration successful Bit1: Encoder and servo drive 1: Error 0: Normal Bit0: Image board 1: Error 0: Normal	1
29、30	Reserved				2
31	Checksum	U8		Sum from the 0th byte and take the least significant 8 bits.	1

Table 3 Aircraft Attitude and Latitude-Longitude Information

Data source		Controller			
Destination		DYT			
Transmission Frequency		Transmit periodically at a frequency of 1 to 60 Hz.			
Byte Sequence Number	Parameter Name	Data Type	Unit	Explanation	Bytes Occupied
0	Sync Word 1	U8		0xEB	1
1	Sync Word 2	U8		0x91	1
2、3	Aircraft Roll Angle	S16	0.01°	Viewing from the tail to the head of the aircraft; Azimuth angle: zero when the nose points due north, positive when the nose points east of north, and negative when it points west of north; Pitch angle: the angle between the nose and the horizontal plane, zero at horizontal, positive when the nose is up, and negative when it is down; Roll angle: zero when the fuselage is horizontal, positive when tilted to the right, and negative when tilted to the left (send 0 if not available).	2
4、5	Aircraft Pitch Angle	S16	0.01°		2
6、7	Aircraft Yaw Angle	S16	0.01°		2
8~11	Latitude	Int32	10 ⁻⁷ °		4
12~15	Longitude	Int32	10 ⁻⁷ °		4
16、17	Altitude	S16	0.2m		2

18、19	Relative Height	S16	0.2m		2
20	Year	U8		+2000	1
21	Month	U8			1
22	Day	U8			1
23	Hour	U8			1
24	Minute	U8			1
25	Second	U8			1
26	Centisecond	U8	10ms		1
27、28	Airspeed	U16	0.5m/s		2
29、30	Satellite Ground Speed	U16	0.5m/s		2
31	Checksum	U8		Sum from the 0th byte and take the least significant 8 bits.	1
	Total				32

Table 4 Target Latitude-Longitude Information

Data source		Controller			
Destination		DYT			
Transmission Frequency		Transmit periodically at a frequency of 1 to 60 Hz, determined by the aircraft's latitude-longitude and laser ranging frequency.			
Byte Sequence Number	Parameter Name	Data Type	Unit	Explanation	Bytes Occupied
0	Sync Word 1	U8		0xEE	1
1	Sync Word 2	U8		0x18	1
2~5	Latitude	Int32	10 ⁻⁷ °		4
6~9	Longitude	Int32	10 ⁻⁷ °		4
10、11	Altitude	S16	0.2m		2
12、13	Relative Height	S16	0.2m		2
14	Year	U8		+2000	1
15	Month	U8			1
16	Day	U8			1
17	Hour	U8			1
18	Minute	U8			1

19	Second	U8			1
20	Centisecond	U8	10ms		1
21~30	Reserved				10
31	Checksum	U8		Sum from the 0th byte and take the least significant 8 bits.	1
	Total				32

Table 5 Single Status Return

Data source		Controller			
Destination		DYT			
Transmission Frequency		Trigger transmission			
Byte Sequence Number	Parameter Name	Data Type	Unit	Explanation	Bytes Occupied
0	Sync Word 1	U8		0xEE	1
1	Sync Word 2	U8		0x19	1
2	Corresponding Control Code	U8		The control code corresponding to this status	1
3	Parameter Length	U8		N	1
4~N+3	Parameter			When N is 0, there is no parameter	N
N+4	Checksum	U8		Sum from the 0th byte and take the least significant 8 bits	1

When the control code is 0x3a "digital guidance", the parameter length is 2.

Byte Sequence Number	Parameter Name	Data Type	Unit	Explanation	Bytes Occupied
4	Digital Guidance Command	U8		0x00: Exit Geographic Tracking 0x01: Geographically Track the Current Field of View Center Position 0x02: Geographically Track a Specified Position 0x0a: Calibrate Based on Known Targets	1
5	Status	U8		0 indicates success, and 1 indicates failure.	1

When the control code is 0xb0 "Lifting Control", the parameter length is 1.

Byte Sequence Number	Parameter Name	Data Type	Explanation	Bytes Occupied

4	Lifting Status	U8	0 indicates stop, 1 indicates ascent, 2 indicates descent, 3 indicates ascent in place, 4 indicates descent in place, and 0xff indicates an error.	1
---	----------------	----	--	---

Table 6 SEI Information

Data source		Pod Video			
Destination		Video Transmission			
Transmission Frequency		30Hz			
Byte Sequence Number	Parameter Name	Data Type	Unit	Explanation	Bytes Occupied
0	Sync Word 1	U8		0xEE	1
1	Sync Word 2	U8		0x16	1
2	Status Information Feedback 1	U8		Bits 7-6: Tracked video source 00: Visible light 1 01: Visible light 2 10: Infrared 1 11: Infrared 2 Bits 5-4: Tracking algorithm type 00: Adaptive 01: Personnel 10: Vehicle 11: Building Bit 3: Target automatic prompt 1: On 0: Off Bit 2: Target tracking status 1: Locked 0: Searching Bits 1-0: Spare	1
3	Status Information Feedback 2	U8		Bit7: Image enhancement 1: On 0: Off Bit6: Reserved Bit5: Storage 1: On 0: Off Bit4: Reserved Bit3: Motor status 1: On 0: Off Bit2: Follow mode 1: On 0: Off	1

				Bit1: Spare Bit0: Spare	
4	Zoom Magnification Low 8 Bits	U8	0.1x	Combined with bits 0-3 of byte 5 to form a u16.	1
5	Abnormal Information	U8		Bits 7-6: Displayed large screen Bits 5-4: Displayed small screen 00: Visible 1 (Zoom/Forward View) 01: Visible 2 (Wide-Angle/Side View) 10: Infrared 1 11: Infrared 2	1
				Bits 0-3: High 4 bits of zoom magnification.	
6、7	Target Miss Distance X-axis Offset Angle	S16	0.05°	It represents the horizontal and vertical deviations of the locking point, with the image center point as 0. The values correspond to direct physical quantities, and the different field angles of visible light and infrared lenses are uniformly calculated by the pod's internal system.	2
8、9	Target Miss Distance Y-axis Offset Angle	S16	0.05°		2
10、11	Roll Frame Angle	S16	0.01°	Left is negative and right is positive. Up is positive and down is negative.	2
12、13	Pitch Frame Angle	S16	0.01°		2
14、15	Azimuth Frame Angle	S16	0.01°		2
16、17	Reserved				2
18、19	Reserved				2
20、21	Roll Angular Velocity	S16	0.01°/s		2
22、23	Pitch Angular Velocity	S16	0.01°/s		2
24、25	Azimuth Angular Velocity	S16	0.01°/s		2
26、27	Laser Ranging	U16	0.1m	0 indicates invalid.	2
28	Self-Test Result	U8			1
29、30	Reserved				2
31、32	Aircraft Roll Angle	S16	0.01°	Viewing from the tail to the head of the aircraft: Azimuth angle: Zero when the nose points due north, positive when the nose points east of north, and	2
33、34	Aircraft Pitch Angle	S16	0.01°		2
35、36	Aircraft Yaw Angle	S16	0.01°		2

				<p>negative when it points west of north.</p> <p>Pitch angle: The angle between the nose and the horizontal plane, with zero at horizontal. It is positive when the nose is upward and negative when downward.</p> <p>Roll angle: Zero when the fuselage is horizontal, positive when the aircraft banks to the right, and negative when it banks to the left (send 0 if absent).</p>	
37~40	Latitude	Int32	10 ^{^-7} °		4
41~44	Longitude	Int32	10 ^{^-7} °		4
45、46	Altitude	S16	0.2m		2
47、48	Relative Height	S16	0.2m		2
49	Year	U8		+2000	1
50	Month	U8			1
51	Day	U8			1
52	Hour	U8			1
53	Minute	U8			1
54	Second	U8			1
55	Centisecond	U8	10ms		1
56、57	Airspeed	U16	0.5m/s		2
58、59	Satellite Ground Speed	U16	0.5m/s		2
60	Frame Count	U8	0-255 cycle		1
61、62	Reserved				2
63	Checksum	U8		Start adding from byte 0 and take the lower 8 bits.	1
	Total				64

2.3 Network Control

When network control is required, establish a TCP connection to port 2000 of the pod. The TCP protocol is encapsulated based on the above-mentioned protocol, while the protocol returned by the pod remains unchanged as described above.

Byte Sequence Number	Name	Content	Explanation
0	Frame Header	0xeb	
1	Frame Header	0x90	
2	Data Length	N	U8 type, where N is the data length.
3~2+N	Data	EB 90.....	
3+n	Checksum		Start accumulating from the 3rd byte and take the lower eight bits.

Example: eb 90 10 eb 90 2b 00 00 00 00 00 00 00 00 00 00 00 00 00 00 a6 4c (4c is the checksum, starting accumulation from the second eb)

Where: eb 90 2b 00 00 00 00 00 00 00 00 00 00 00 00 00 a6 is the valid data (a6 is the checksum, starting accumulation from eb)

DYT HOST COMPUTER SOFTWARE OPERATION INSTRUCTIONS

1. Connection Schematic Diagram

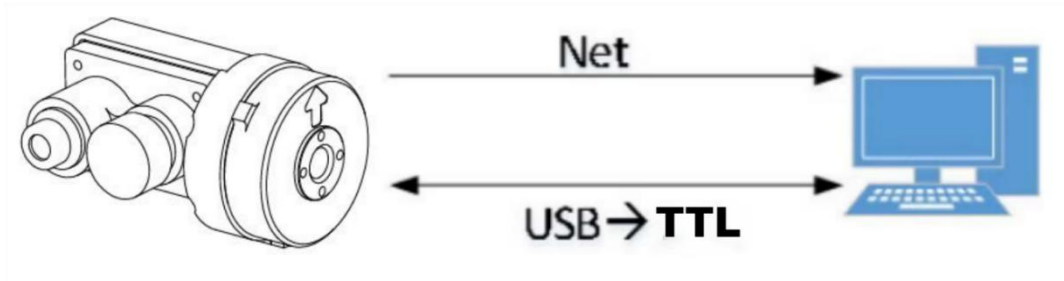

Figure 1 Test Connection Schematic Diagram

2 Pre-power-on Preparations

2.1 Pre-power-on Preparations

- 1) Please install the pod in a suspended manner as shown in Figure 2.
- 2) Connect the wires according to the correct wiring sequence.
- 3) Use a USB-to-TTL cable and a network cable to connect the pan-tilt to the computer.
- 4) Check the power supply voltage, then power on.

3 Operation of the Host Computer

3.1 Power On

Turn on the control software and connect the pod's video source and control interface to the computer according to requirements.

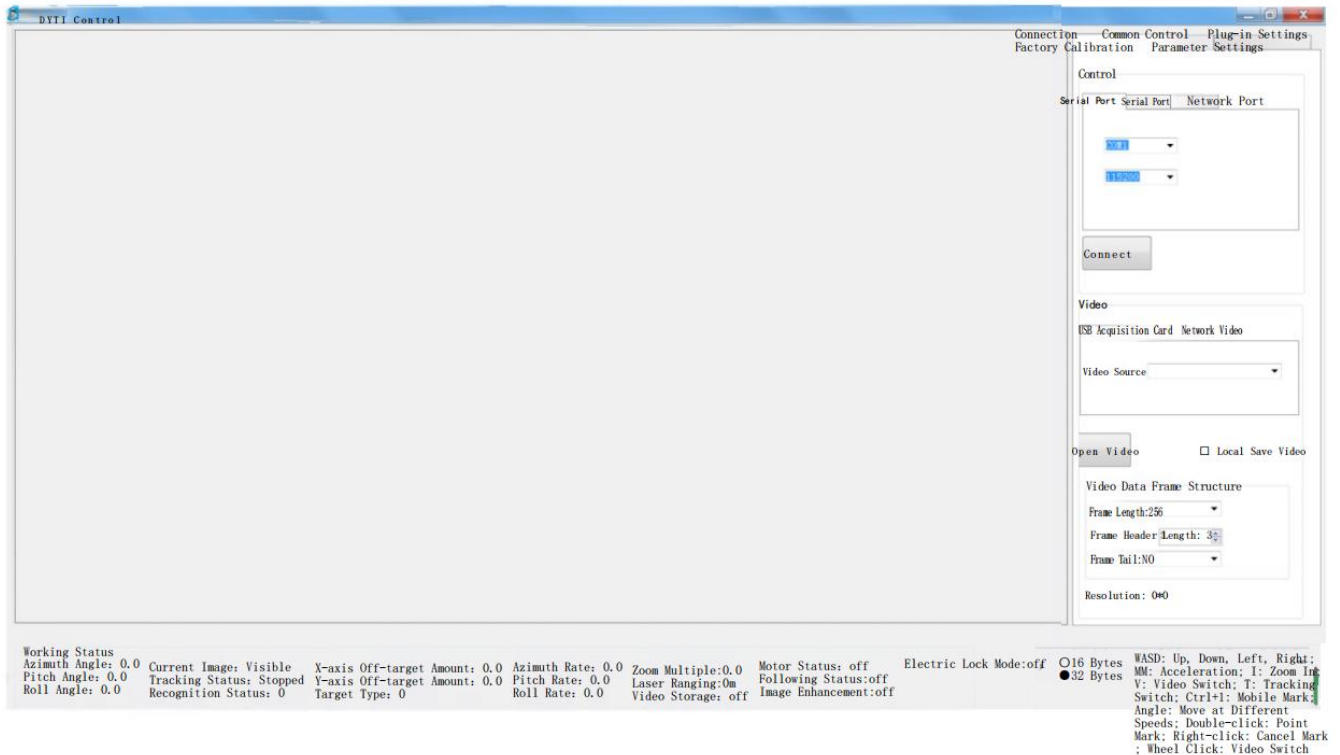

Figure 3 Open Interface

3.1.1 Control Interface Connection

The control interface supports serial port control or network port control.

For serial port control: As shown in Figure 4-1, select the "Serial Port" tab, click the serial port drop-down list, select the corresponding serial port number of the pod, and click "Connect".

For network port control: As shown in Figure 4-2, select the "Pod Network Port" tab, enter the pod's IP, check "Add EB90", and click "Connect".

After a successful connection, the pan-tilt status will be updated in real time at the lower left corner.

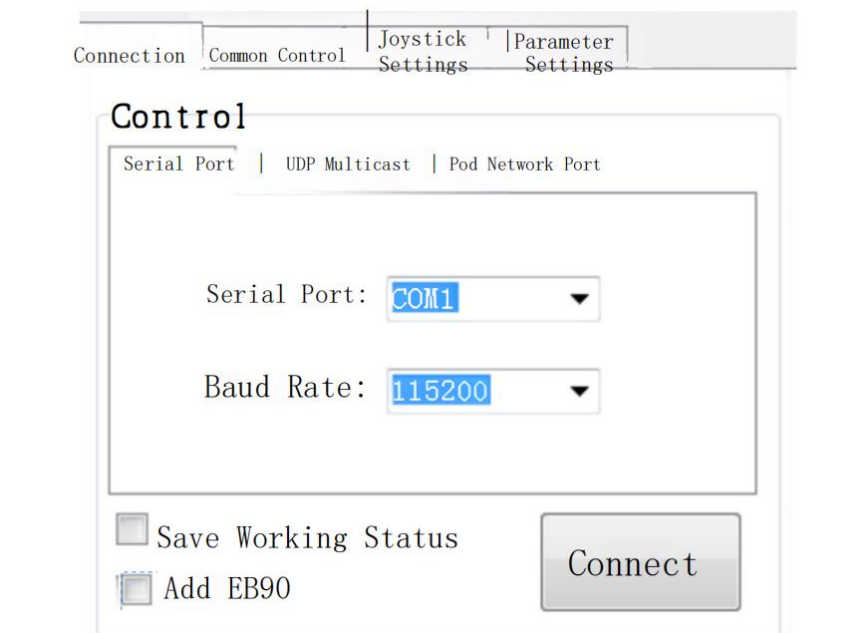

Figure 4-1 Serial Port Connection

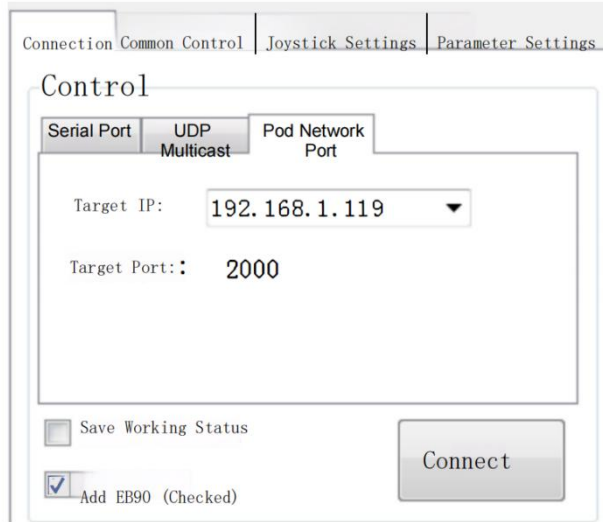

Figure 4-2 Network Port Connection

3.1.2 Turn on Video

The host computer supports two video input methods: USB capture card input and network input.

- 1) Make wiring according to the input method (completed before power-on).
- 2) As shown in Figure 5-1 and Figure 5-2, select the corresponding tab according to the input method.
- 3) Enter the video source for USB capture card input or the video stream address for network input.
- 4) Click the "Turn on Video" button (wait for a few seconds; if the connection is successful, the pan-tilt live video will be displayed in the video window).

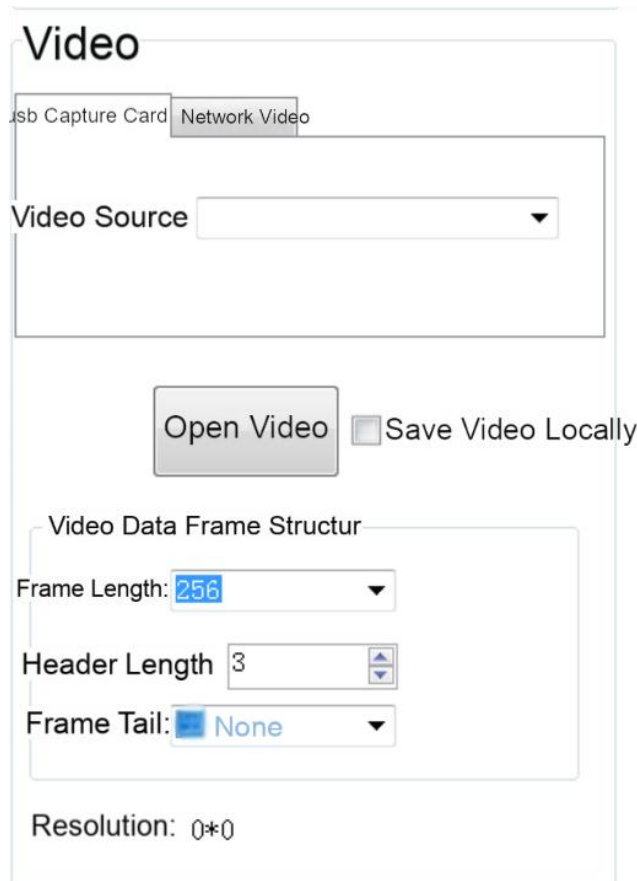

Figure 5-1 USB Capture Card Input

Video

usb Capture Card | Network Video

IP:

Parse Frame Structure

Save Video Locally

Video Data Frame Structure

Frame Length:

Header Length

Frame Tail:

Resolution: 0*0

Figure 5-2 Network Input

3.2 Common Controls

3.2.1 Pod Rotation

Table 1

No.	Button/Input Box	Functions
1	Up/Down/Left/Right/Stop	Control the rotation direction of the pod.
2	Center	Rotate the pod to the zero position.
3	On/Off Motor	Control the power on/off of the motor.
4	Azimuth Follow/Stop Following	Control whether the pod's azimuth axis follows the aircraft's rotation.
5	Specified Angle	Control the pod to rotate to a specified angle (values in the azimuth and pitch input boxes).

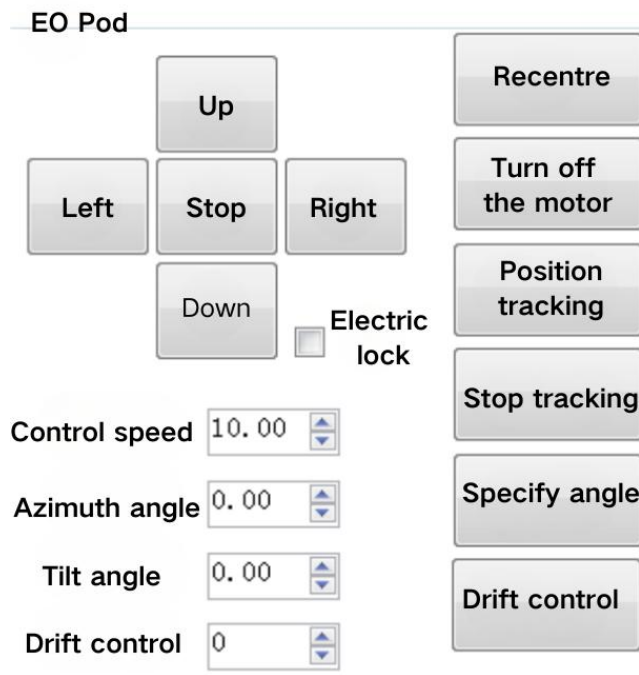

Figure 6 Pod Rotation Control

3.2.2 Target Tracking

Table 2

No.	Button/Input Box	Functions
1	Double-click in the video	Track a specified target.
2	Right-click in the video	Cancel tracking.
3	Start tracking	Directly track the target at the center of the video.
4	Stop button	Cancel tracking.
5	Turn on/off person-vehicle recognition	Turn on or off the person-vehicle recognition function.
6	Automatic recognition to tracking	Retain.
7	Semi-automatic tracking	Suitable for tracking person-vehicle targets, and the tracking process will be corrected according to the recognition algorithm.
8	Traditional tracking	Traditional tracking algorithm that does not recognize targets.

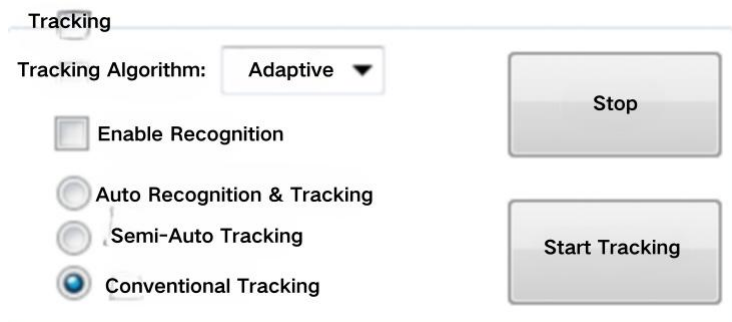

Figure 7 Target Tracking

3.2.3 Image Display

There are mainly two types of display screens: visible light and infrared. Among them, infrared has two colors: white hot and black hot, and digital zoom can be performed on both visible light and infrared respectively.

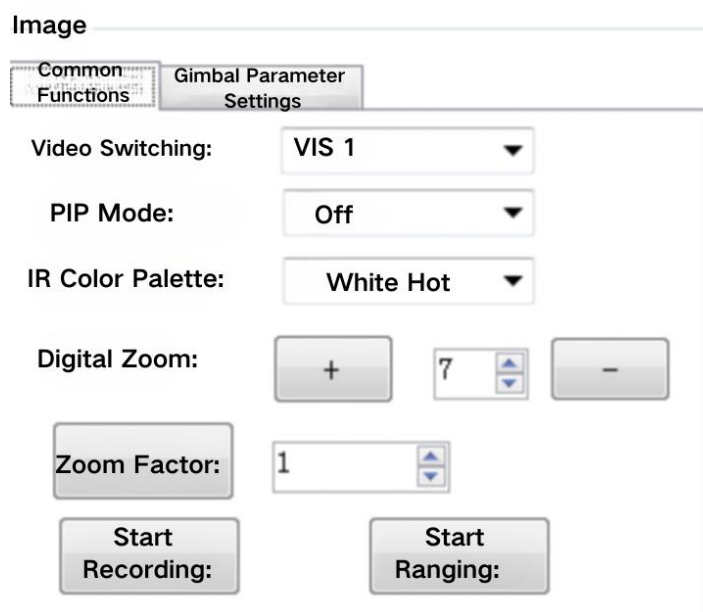

Figure 8 Image Display Control - Common Functions

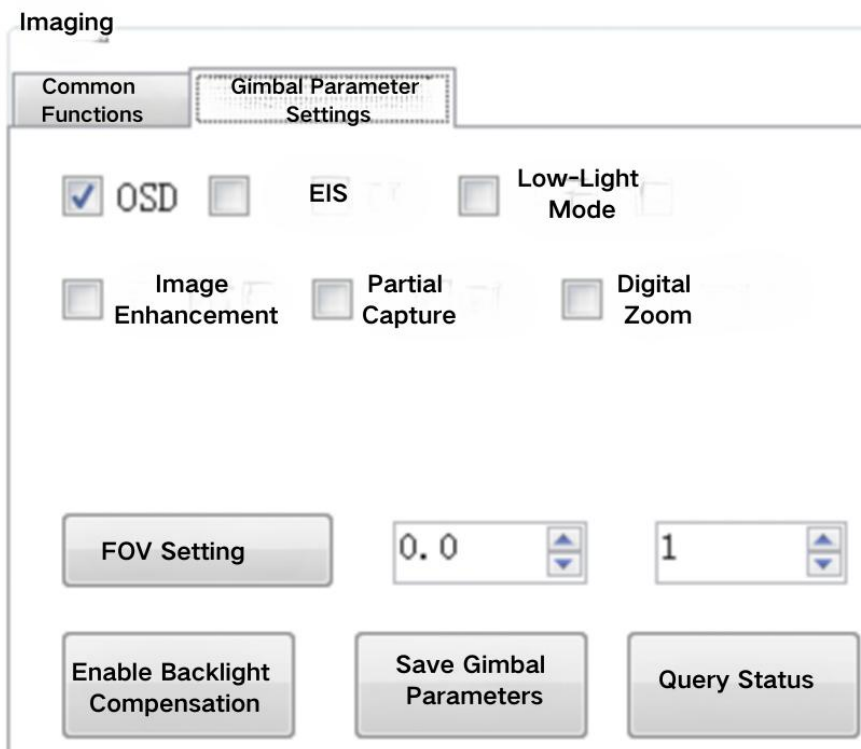

Figure 9 Image Display Control - Movement Parameter Settings

Table 3

No.	Button/Input Box	Functions
1	OSD (On-Screen Display)	Turn on or off the OSD (On-Screen Display) of the screen.
2	Electronic Image Stabilization	Enable or disable electronic image stabilization (supported by some pods).
3	Low-Light Mode	Activate low-light mode when the illumination is dim.
4	Image Enhancement	Activate image enhancement mode when there is fog.
5	Local Image Capture	Retain.
6	Electronic Zoom	Enable or disable electronic zoom (supported by some pods).

3.2.4 Laser Ranging

As shown in Figure 8, clicking the "Start Ranging" button enables the laser ranging function. The measured values can be viewed in the parameter display area, as shown in Figure 10.

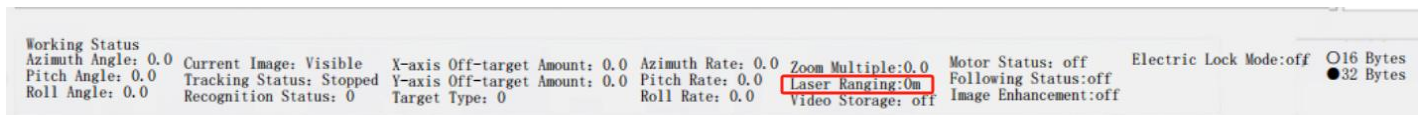

Figure 10 Laser Ranging Parameter Display Area

3.3 Common Issues

3.3.1 Finding the Serial Port Number

Right-click the "Computer" icon, select "Properties", click Device Manager, and the interface shown in Figure 11 will appear. In general, the selected serial port number is the one that refreshes after inserting the connection cable (or port number). Double-click "Ports (COM & LPT)", and the refreshed USB port is the selected port.

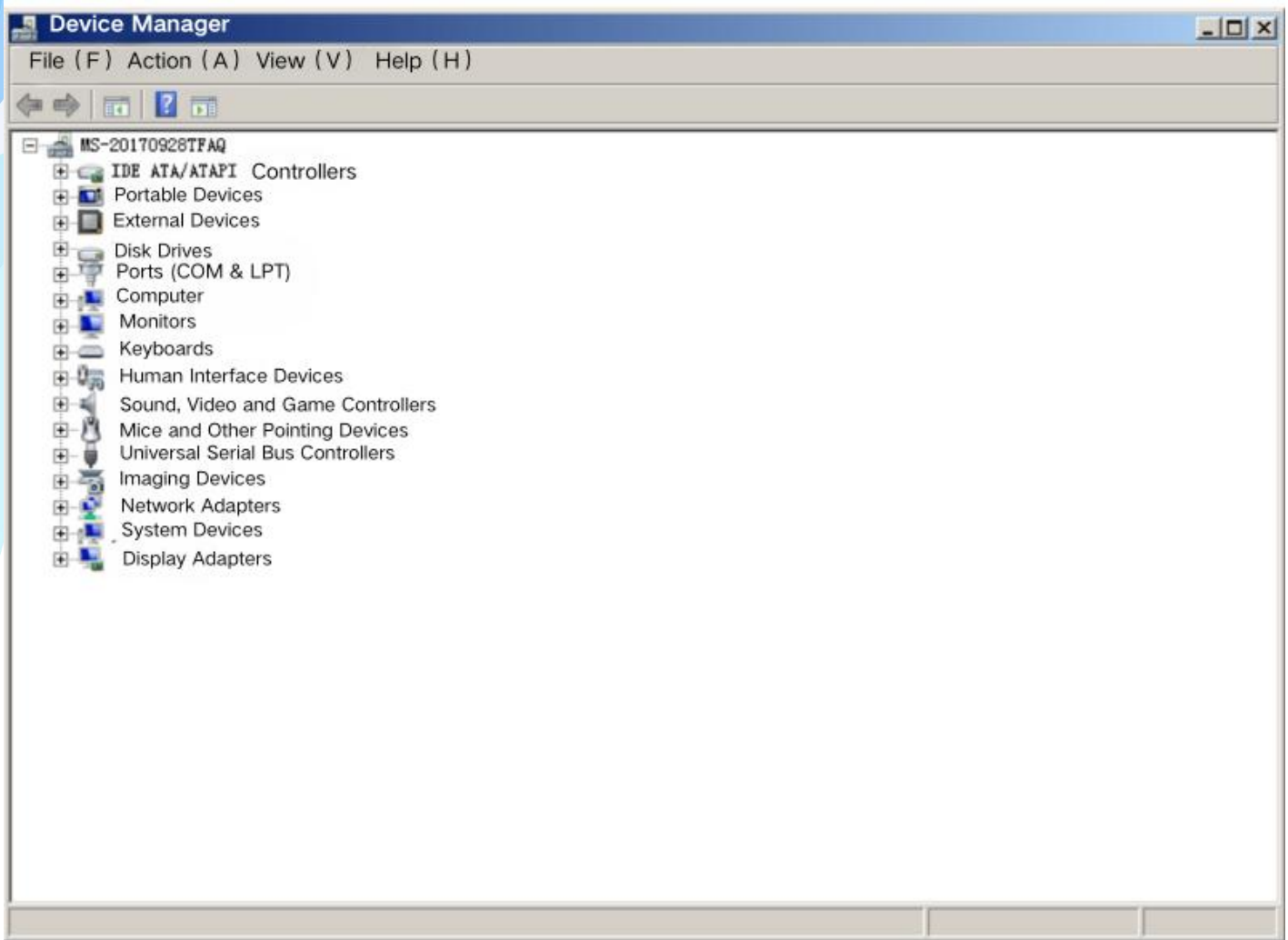

Figure 11 Device Manager

3.3.2 No Network Video Output

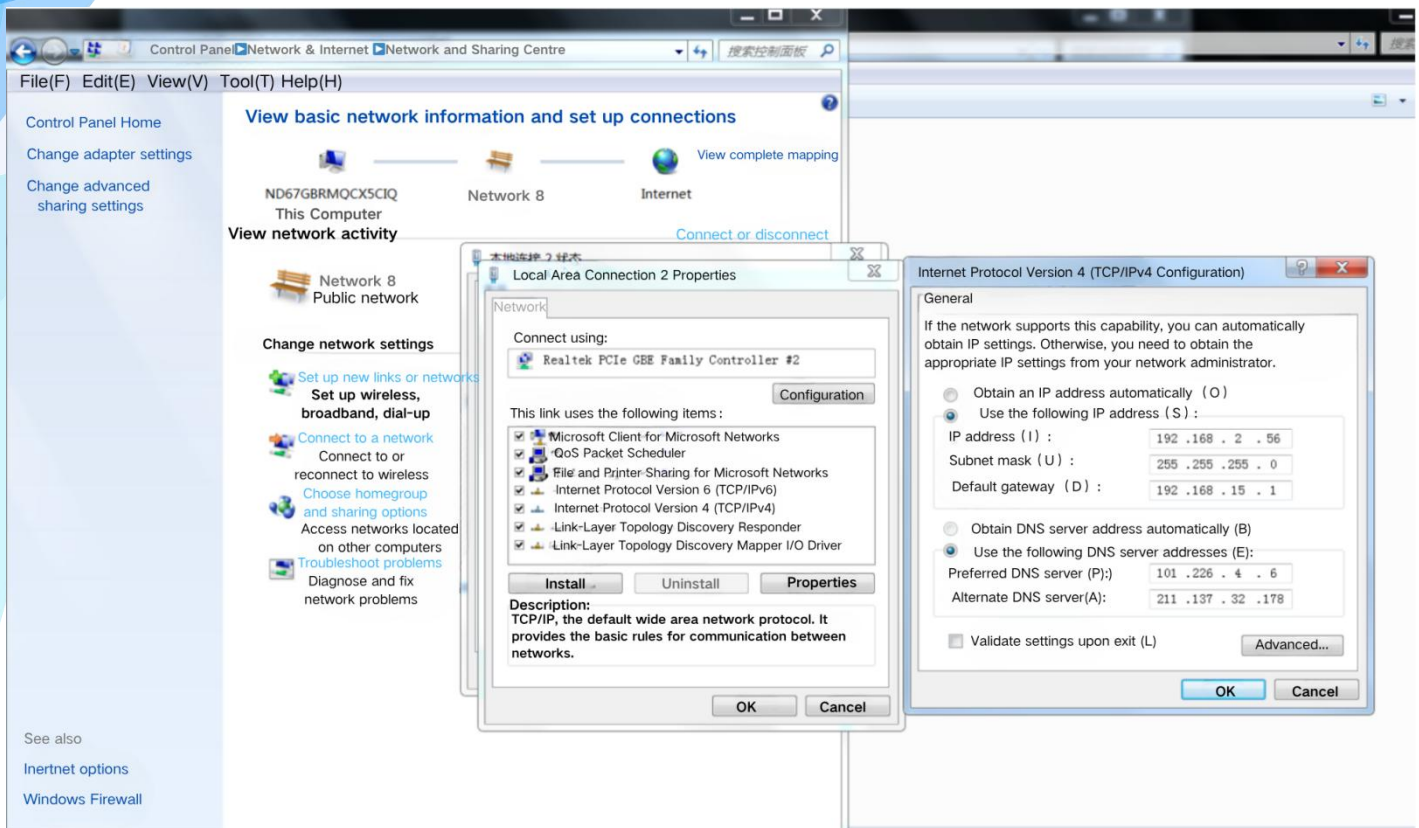

Figure 12 IP Address Modification

- 1) On the computer, open "Control Panel" → Network and Internet → "Network and Sharing Center";
- 2) Click the "Local Area Connection" icon → "Properties", then double-click "Internet Protocol Version 4 (TCP/IPv4)";
- 3) Ensure that the computer's IP address is in the same network segment as the video stream address. For example, if the video stream address is `rstp://192.168.2.119/554`, the computer's IP address can be set to 192.168.2.56;
- 4) Turn off the firewall;
- 5) Click the "Open Video" button on the host computer, and the imaging video will be displayed on the right side of the host interface.

PRECAUTIONS FOR USE AND MAINTENANCE

1. The daily maintenance tasks for operators are limited to replacing or inspecting cables, performing routine cleaning, and conducting functional checks to ensure the instrument remains in good technical condition.
2. Do not open the casing without authorization. There are no user-repairable components inside the machine. When a system failure occurs, the manufacturer's technical personnel should locate the fault before proceeding with repairs.
3. If the product is stored for a long period or not in use, it should be kept in a cool and dry environment.
4. When inserting user interface connectors, ensure they are aligned correctly before insertion. Do not pull directly on the cable when plugging or unplugging the connector.
5. All parameters of the product are debugged before leaving the factory. Unless otherwise specified, it is recommended to use the recommended configuration parameters.
6. If used on an aircraft, the overall performance is affected by the aircraft's weight, power system, flight control system, and user settings. Users must possess considerable professional capabilities and must debug the product to the approved performance before field use.
7. Under no circumstances should the thermal imaging lens be directed directly at the sun.

8. The SD card should be removed when the system is powered off.
9. Keep the front lens clean and free of debris.
10. The first four seconds after the pod is powered on are for automatic gyro calibration. During this period, keep the pod as stable as possible without vibration; otherwise, the gyro data from the last startup will be used. If the pod drifts, restart it or send a gyro calibration command.
11. The control software must run on a 64-bit system computer.